

## Azadirachta Indica 엑스와 요드화이온이 산성매체에서 Al 부식방지에 대한 Synergistic 효과

S. T. Arab\*, A. M. Al-Turkustani, and R. H. Al-Dhahiri

King Abd El-Aziz University, Girls College of Education, Chemistry Department, Jeddah, KSA

(2007. 12. 27 접수)

## Synergistic Effect of *Azadirachta Indica* Extract and Iodide Ions on the Corrosion Inhibition of Aluminium in Acid Media

S. T. Arab\*, A. M. Al-Turkustani, and R. H. Al-Dhahiri

King Abd El-Aziz University, Girls College of Education, Chemistry Department, Jeddah, KSA

(Received December 27, 2007)

**요약.** Potentiodynamic 분광작용과 임피던스 기술을 이용하여 요드화 이온으로 *Azadirachta Indica* 엑스가 존재하는 0.5 M HCl 용액 속의 Al 에 대한 부식 방지 작용을 상승시켰다. 이는 0.5 M HCl 용액에서 *AZI* 엑스가 Al의 부식을 방지함을 발견하였다. *AZI* 엑스 농도가 24% v/v 이전에는 농도가 커짐에 따라 방지효율도 따라서 커진다. 하지만 *AZI* 엑스 농도가 더 커지면 Inh. %는 오히려 작아진다. 요드화 이온의 증가는 방지효율을 상당한 양으로 강화시킨다. 요드화 이온이 혼합적으로 존재할 때 Inh. %값은 증가한다. 이는 낮은 *AZI* 엑스 농도에서 *AZI* 엑스는 joint adsorption을 통하여 insoluble complex을 형성한다. 하지만 높은 *AZI* 엑스 농도에서는 요드화 이온과 형성한 complex 사이에 competitive adsorption이 나타나 낮은 Inh. %를 초래한다. At all studied 요드화 이온의 농도에서 요드화 이온과 *AZI* 엑스가 동시에 존재할 때의 Inh. %값은 *AZI* 엑스만 존재할 때보다 감소된다. Synergism parameter  $S_0$ 는 표면 Coverage 값으로 계산된다. 이 Parameter는 *AZI* 엑스 경우 unity 보다 더 큼을 알 수 있다. 이는 요드화 이온의 증가로 인하여 방지효율이 강화 되었음을 제시한다.

**주제어:** 요드화 이온, *Azadirachta Indica* 엑스, 방지효율

**ABSTRACT.** The synergistic action caused by iodide ions on the corrosion inhibition of aluminium (Al) in 0.5 M HCl in the presence of *Azadirachta Indica* (*AZI*) plant extract has been investigated using potentiodynamic polarization and impedance techniques. It is found that *AZI* extract inhibits the corrosion of aluminium in 0.5 M HCl. The inhibition efficiency increases with the increase in *AZI* extract concentration, until 24% v/v of *AZI* extract, then Inh.% is decreased with further increase in *AZI* extract concentration. The adsorption of this extract in the studied concentration is found to obey Freundlich adsorption isotherm. The addition of iodide ions enhances the inhibition efficiency to a considerable extent. The increase in Inh.% values in presence of fixed concentration of iodide ions indicates that *AZI* extract forms an insoluble complex at lower *AZI* extract concentrations by undergoing a joint adsorption. But at higher concentrations of *AZI* extract, competitive adsorption is found between iodide ions and the formed complex leading to less Inh.%. The Inh.% decreased in presence of iodide ions with *AZI* extract than in presence of *AZI* extract alone at all studied iodide concentrations. The synergism parameter  $S_0$  is defined and calculated from surface coverage values. This parameter in the case of *AZI* extract is found to be more than unity, indicating that the enhanced inhibition efficiency caused by the addition of iodide ions.

**Keywords:** Iodide ions, *Azadirachta Indica*, Corrosion inhibition

## INTRODUCTION

Corrosion is the deterioration of metal by chemical attack or by reaction with its environment. It is a constant and continuous problem and it is impossible to eliminate it entirely.<sup>1</sup>

One of the methods used to reduce the rate of metal corrosion is the addition of inhibitors. A lot of substances are known as inhibitors such as some organic compounds, but because of the toxic nature and high cost of some chemicals currently in use it is necessary to develop environmentally acceptable and less expensive inhibitors. Many studies have been carried out to find suitable compounds to be used as corrosion inhibitors.<sup>2</sup> Natural products of plant origin can be considered as a good source for this purpose.<sup>3</sup>

*Azadirachta Indica* (AZI), the *Neem* tree, grows in many parts of Saudi Arabia. This tree as well as the chinaberry tree, are evergreen flowering plants belonging to family Meliaceae.<sup>4</sup> The active principles in fruits, kernels and leaves of the *Neem* and the closely related chinaberry tree are several tetranotipenoids. Its structure shows some similarities to that steroid hormones, which play role in the reproduction and development of used.<sup>5</sup>

Halides have been reported to inhibit or stimulate the corrosion of some metals and metal alloys in strong acids depending on the ionic size and charge, the electrostatic field set up by the negative charge of the anion on adsorption sites and the nature and concentration of halide ions.<sup>6-11</sup>

Synergism is a combined action of compounds greater in total effect than the sum of the individual effects. Synergism of corrosion inhibitors is either due to the interaction between components of the inhibitor composition or due to the interaction between the inhibitor and one of the ions present in the solution.<sup>12</sup>

The aim of the present work is to study the action of *Azadirachta Indica* extract (*Neem* leaves), iodide

ions, also, the synergistic behaviour between AZI and I ions on the corrosion of aluminium (Al) in 0.5 M HCl solution at 30 °C.

## EXPERIMENTAL

The effect of *Azadirachta Indica* (AZI) (*Neem* leaves) extract on the corrosion of Al sample in 0.5 M HCl solutions in absence and presence of NaI at 30 °C was studied using electrochemical (polarization and impedance) methods. Scanning electron microscopy (SEM) measurements also at 30 °C was carried out.

All chemicals used were of grade reagents (A.R.). Deionised water was used in the preparation of the solutions.

The sample used in this study was aluminium which has the following chemical composition (Table 1):

Al electrode was in the form of rode, embedded in glass tubes and fixed by Araldite adhesive (Ciba product, Switze, Land). The reference electrode was Ag/Ag<sub>2</sub>Cl<sub>2</sub>/Cl<sup>-</sup>. The auxiliary electrode was a platinum electrode. Before immersion in the test solution the surface was mechanically polished using finer grades of emery papers and then washed with deionised water and the solutions were deaerated with 99.999% pure nitrogen gas. The temperature was adjusted by using an ultra thermostat (Julabo U3 No. 8311) at 30 °C ± 0.02 °C.

Stock solution of the inhibitor extract was prepared by boiling 0.7 kg of *Azadirachta Indica* leaves in boiled deionised water and left all night and then mixed in a plinder, filtered and the solution was kept in refrigerator at low temperatures.

Potentiodynamic polarization and electrochemical impedance spectroscopy (EIS) measurements were carried out using an impedance spectrum analyzer (ACM Gill AC) connected to a Samsung computer (Bridge DVD ASUS 8X max).<sup>13</sup> Potentiodynamic polarization measurements were car-

Table 1. Chemical composition of Aluminum sample

Element	Mn	Ni	Fe	Pb	Si	Zn	Cr	Al
%	0.009	0.043	0.765	0.014	2.242	1.621	0.009	95.297

ried out after finish impedance measurements. The equilibrium potential was calculated at equilibrium between anodic and cathodic reactions (about 15 min.). At open circuit potential, the electrode was anodically and cathodically polarized at the same rate. The anodic and cathodic polarization curves were recorded and calculated. Corrosion current density ( $I_{\text{corr}}$ ) and corrosion potential ( $E_{\text{corr}}$ ) by Tafel extrapolating.

EIS measurements were carried out in the frequency range 0.5 Hz–10000 KHz. The input signal amplitude was 10 mV peak to peak in both high and low frequency ranges at open circuit potential ( $E_{\text{oc}}$ ).

Scanning electron microscopy (SEM) was employed to study the surface morphology by Scanning Electron Microscopy XL 20 PHILIPS with different magnification.

## RESULTS AND DISCUSSION

### Effect of Azadirachta Indica Extract

The effect of the naturally occurring compound *Azadirachta indica* (AZI) plant (leaves) on the corrosion behaviour of Al in 0.5 M HCl at 30 °C was investigated using electrochemical (polarization and impedance) measurements.

Cathodic and anodic polarization curves and Nyquist plots for aluminium dissolution in 0.5 M HCl solution in absence and presence of the different concentrations of AZI extract at 30 °C are shown in Fig. 1. Table 2 collects the values of the various

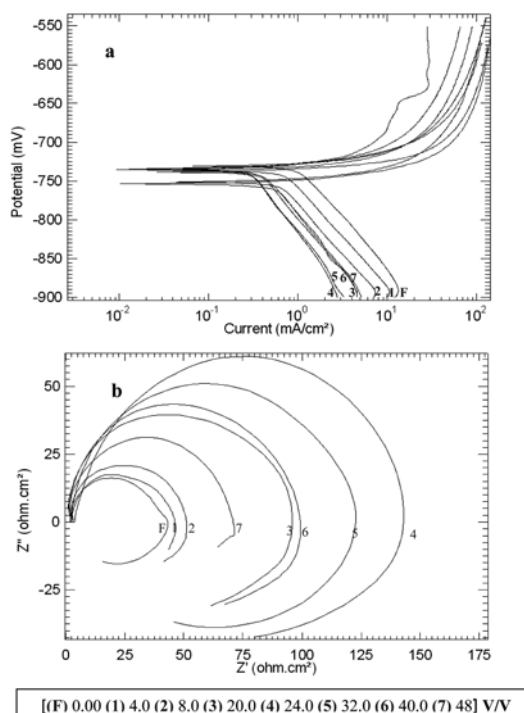

Fig. 1. Electrochemical behavior of aluminum sample corrosion in 0.5 M HCl at different concentrations of AZI extract at 30 °C from (a) Polarization, (b) impedance.

electrochemical parameters and corrosion inhibition efficiency (Inh. %) as being associated. It is evident that the corrosion rates is reduced with increasing AZI extract concentration, until 24 % v/v of extract, then an increase in the corrosion rates with increasing the extract concentration is occurred. So, the inhibition efficiency for the corrosion of Al

Table 2. Electrochemical parameters and inhibition efficiency for corrosion of aluminum in 0.5 M HCl in absence and presence of different concentrations of Azadirachta indica extract at 30 °C.

Conc. V/V	Polarization					Inh.%	Impedance			
	$-E_{\text{corr}}$ (mV)	$b_a$ (V dec <sup>-1</sup> )	$-b_c$ (V dec <sup>-1</sup> )	$I_{\text{corr}}$ (mA. cm <sup>-2</sup> )	$R_{\text{corr}}$ (mm day <sup>-1</sup> )		$R_{\text{sol}}$ ( $\Omega$ cm <sup>2</sup> )	$R_{\text{ct}}$ ( $\Omega$ cm <sup>2</sup> )	$C_{\text{dl}}$ ( $\mu$ F)	Inh.%
0.0	726.57	44.55	131.22	7.28	79.30	-----	0.584	42.52	102.5	-----
4	735.78	67.96	124.86	6.72	73.14	<b>7.720</b>	2.153	44.16	127.2	<b>4.170</b>
8	748.61	83.63	51.64	6.51	70.94	<b>10.60</b>	2.286	48.82	115.8	<b>16.67</b>
20	734.79	97.34	29.41	6.09	66.33	<b>16.37</b>	1.145	94.88	782.0	<b>54.17</b>
24	732.82	56.04	105.58	4.00	43.63	<b>45.07</b>	2.898	139.40	553.1	<b>70.13</b>
32	733.35	137.48	153.51	4.89	53.31	<b>32.85</b>	1.911	119.60	671.8	<b>65.17</b>
40	728.87	68.51	38.34	5.42	59.06	<b>25.57</b>	0.379	98.47	817.3	<b>58.33</b>
48	747.62	105.18	28.17	6.29	68.51	<b>13.62</b>	1.567	68.94	595.1	<b>37.50</b>

in 0.5 M HCl in the presence of *AZI* gave maximum inhibition at 24% v/v of *AZI* extract. The inhibition efficiency is calculated using the following equations:

$$\theta = 1 - [i_{\text{corr.add}} / i_{\text{corr.free}}] \quad (1a)$$

$$\text{and } \text{Inh.}\% = [i_{\text{corr.add}} / i_{\text{corr.free}}] \times 100 \quad (1b)$$

where  $\theta$  is the degree of surface coverage for different concentrations of the extract in acidic media,  $i_{\text{corr.free}}$  and  $i_{\text{corr.add}}$  are the corrosion current densities in the absence and presence of the extract, respectively and Inh.% is the percentage inhibition efficiency.

Frignani *et al.*<sup>14</sup> have reported that an organic compound formed is a more or less stable complex which has a definite oxidative property.<sup>15</sup> At lower concentrations of *AZI*, (4-24%) v/v, the Inh.% increased with the increase in concentration of *AZI* and an adsorbed intermediate is formed, which may be an insoluble complex leading to increase the values of inhibition efficiency with increasing concentration of the extract. The increase of inhibition efficiency due to this complex arises from the blocking most of the active sites on the metal surface due to increased coverage. But at higher concentrations of the *AZI* extract, the formed complex becomes soluble, this leads to less inhibition. In the case of coverage also, it is found to decrease with increase in the concentration of *AZI*, thereby supporting the fact that an insoluble complex formed at lower concentrations of the *AZI* becomes soluble at higher concentrations, due to the accumulation of a large number of molecules at higher concentrations which makes the complex soluble.

Inspection of the Fig. 1(a) reveals that the polarization curves shifted toward less negative potentials and lower current density values upon the addition of the extract. This behaviour reflects the inhibitive action of *AZI* extract. The cathodic curves plotted in the Tafel plane indicated that the reduction of proton at the Al surface takes place through a charge transfer mechanism. In the anodic domain, it was remarked that the presence of extracts have some effect on the polarization curves

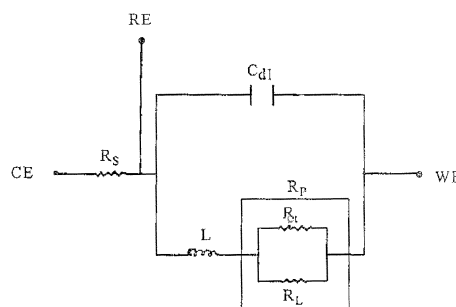

Fig. 2. The equivalent circuit model used to fit the experimental data.

and consequently the extract acts as mixed inhibitor over the electrochemical semi-reactions. The impedance diagrams obtained Fig. 1(b), were perfect semicircles, indicating a charge-transfer process mainly controls the dissolution of Al, and the difference has been attributed to frequency dispersion. The equivalent circuit model used to fit the experimental data is shown in (Fig. 2), as previously reported.<sup>16,17</sup> In this circuit,  $C_{dl}$  is the double layer capacitance,  $R_{ct}$  the interfacial charge-transfer resistance,  $L$  the inductance, and  $R_L$  the inductive resistance.

The data in Table 2 shows that the corrosion potential shifts to less negative values as the concentration of added extract is increased. On the other hand, the corrosion current density is markedly decreased upon addition of the *AZI* extract. The extent of its decrease increases with the increase of extract concentration up to 24% v/v and a reduce in current 45% is found. After this critical concentration, the corrosion current density is markedly increased with more addition of the extract. The decrease of the corrosion rate may be explained by blocking the reduction of  $H^+$  ions on cathodic sites. On the anodic side, the *AZI* extract may be due to the adsorption of its molecules on the Al surface making a barrier for the access of hydrogen ions and then their reduction on the cathodic sites of Al surface. The inhibition efficiency reaches 45.07% at 24% (v/v) and, the  $R_{ct}$  values increased up to 24% (V/V) after that, any addition from *AZI* extract,  $R_{ct}$  is decreased. This confirms the inhibitive nature of *AZI* extracts at these concentrations.

$C_{dl}$  values tended to increase, this will be, caused by the adsorption of *AZI* extract on the Al surface, and, the thickness of the double-layer charges around the Al surface. Also, it is clear from Fig. 1 that, the Nyquist plots showed inductive loops at low frequency. This may explained to be due to a complex formation of *AZI* molecules and Al ions, or presence of pitting corrosion of Cl<sup>-</sup> ions.

With these results, it could be concluded that the aqueous *Azadirachta Indica* plant extract could be used effectively for corrosion prevention of in acidic medium at lower concentrations as much as 24% V/V.

### Adsorption Isotherm

Figures (3a & 3b) show the variation of the inhibition efficiency with logarithm of concentration of *AZI* in 0.5 M HCl at 30 °C from polarization and impedance methodes, respectively. It is clear that, the efficiency goes through a maximum at concentration of *AZI* = 24% v/v. The initial increase in Inh.% can be associated to the increased surface coverage by the adsorbed species. The fallen efficiency at higher concentrations should be the result of desorption of *AZI* due to accumulation of a large number of molecules at higher concentrations up to critical concentration.

The adsorption of *AZI* extract molecules on the Al surface was found to follow the Frewndlish adsorption isotherm which is given by (eqs. (2(a & b))).<sup>18,19</sup>

$$\theta = KC^n \quad (2a)$$

$$\log \theta = \log K + n \log C \quad (2b)$$

where:  $0 < n < 1$ ,  $K$  is the binding constant (equilibrium constant) for the adsorption process and  $C$  is the *AZI* extract concentration in the bulk of the solution.

Figures (4a & 4b) give the results of fitting the data on the Frewndlish isotherm. A straight line fit is observed at 30 °C, which indicates that the adsorption of *AZI* extract molecules on the Al surface is a physical adsorption.

Inspection of the chemical structure of *AZI* extract reveals that the aqueous extract of *AZI* plant is organic in nature and contains, protein, Azadirachtin, Tetranortriterpenoid, Triterpenes, Liminoids, Steroids, etc. These constituents were composed mostly of oxygen-containing organic compounds. These compounds can adsorbed on the Al surface via the lone pairs of electrons present on their oxygen atoms. The adsorption of such compounds on the Al surface make a barrier for charge and mass transfer leading to decrease the interaction of the Al with the corrosive environment. As a result, the corrosion rate of the metal is decreased. Furthermore, these compounds also may form complexes with the metallic cations. These complexes can cause blockage of microanodes and or microcathodes that are generated on the surface under corrosive conditions, and hence can retard the dissolution of the metal.

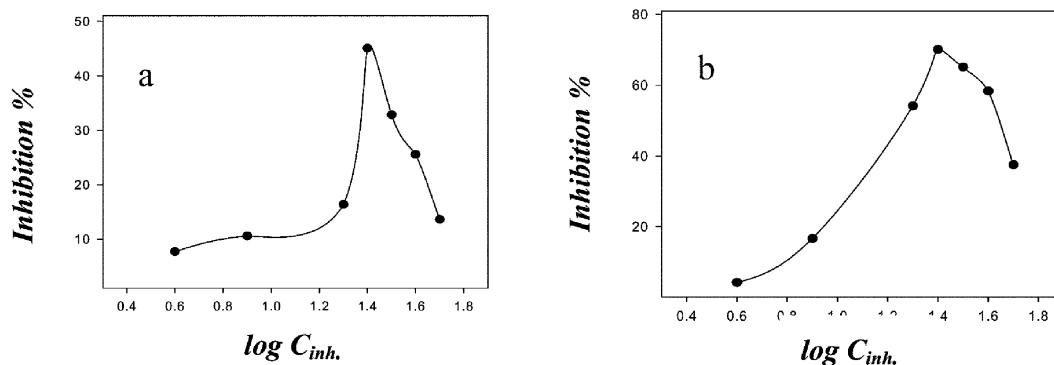

Fig. 3. The relation between inhibition efficiency and the logarithm of concentration of *AZI* extract for the corrosion of Al sample in 0.5 M HCl at 30 °C from (a) polarization (b) impedance.

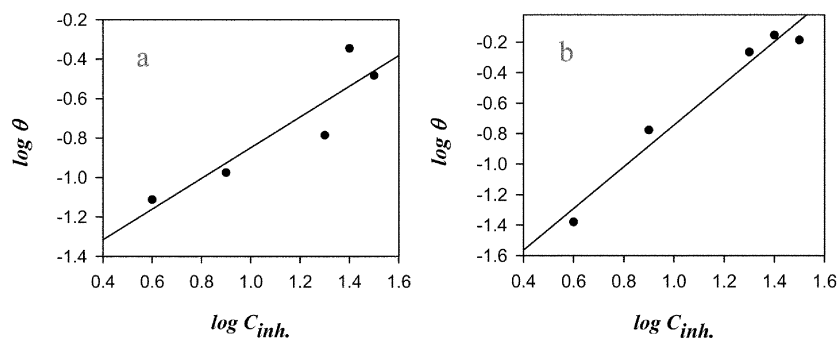

Fig. 4. The relation between  $\log C_{inh}$  and  $\log \theta$  for the corrosion of Al sample in 0.5 M HCl in presence of different concentrations of AZI extract in at 30 °C from (a) polarization, (b) impedance.

### Scanning Electron Microscopy (SEM)

Scanning electron microscope photographs of Al sample were taken before and after corrosion in 0.5 M HCl solutions and in presence of 4% v/v and 24% v/v of AZI extract Figures 5(a-d). Figure (5a) illustrates the clean surface of aluminium sample before immersion in the test solution, while Figure (5b) illustrates the effect of 0.5 M HCl solution on Al specimen at 30 °C after 90 min. immersion. Inspection of these figures it clear that:

- The presence of general corrosion and localized corrosion on Al surface.
- The formation of protective layer on the surface

of Al sample.

Figure (5c) illustrates the effect of 4% v/v of AZI extract at 30°C. It appears that the attacked of acid on Al surface become less and apparently an adsorbed porous layer on Al surface may found.

Figure (5d) illustrates the Al surface after immersion in 0.5 M HCl in presence of 24% v/v of AZI extract, it appears that the surface of Al sample almost free from pits and mostly covers by a protection layer consist of the adsorbed of AZI components on the Al surface. The formed layer nearly compact and thick due to the presence of plenty of molecules of AZI which leads to cover almost all

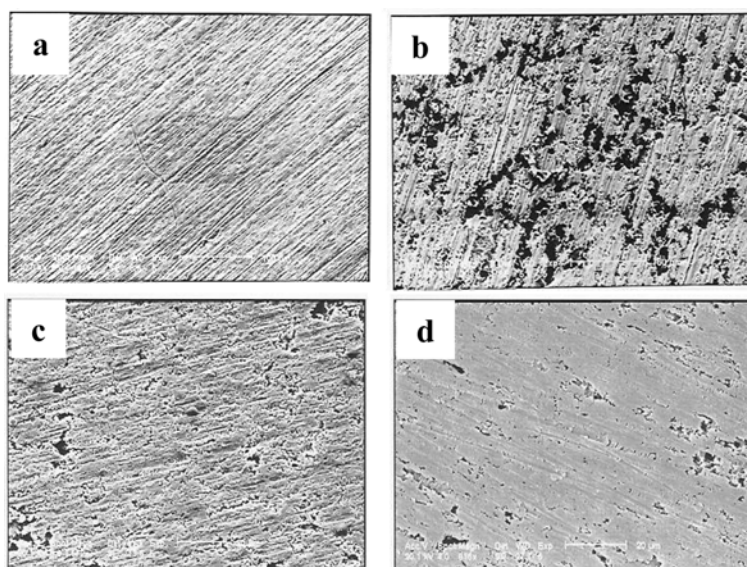

Fig. 5. SEM photographs of aluminium sample, (a) before immersion, (b) after corrosion, (c) in presence of 4% v/v AZI (low concentration) and (d) in presence of 24% v/v of AZI extract (high concentration) in 0.5 M HCl solution at 30 °C.

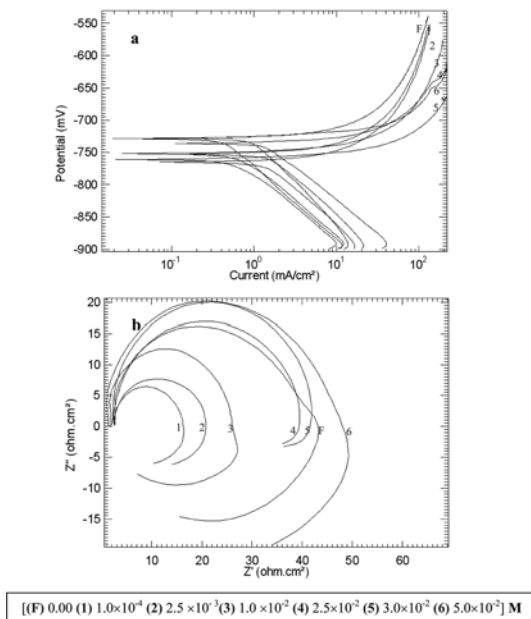

Fig. 6. Aluminum sample corrosion in 0.5 M HCl in absence and presence of different concentrations of I<sup>-</sup> at 30 °C from (a) Polarization, (b) impedance.

the surface of the sample at this concentration.

### Effect of iodide ions on corrosion of aluminum in 0.5 M HCl

Polarization and impedance measurements were used to study the effect of I<sup>-</sup> ions addition on the corrosion of Al sample in 0.5 M HCl solution.

Fig. 6 represents the electrochemical behaviour of Al sample in 0.5 M HCl solutions in absence and presence of various concentrations ( $1.0 \times 10^{-4}$  -  $5.0 \times 10^{-2}$ ) M of I<sup>-</sup> ions at 30 °C.

It is clear that, the addition of I<sup>-</sup> ions leads to accelerate anodic dissolution of Al. It can be observed from the result in Table 3 that the addition of I<sup>-</sup> ions accelerate the corrosion of aluminium sample at low concentrations. By increasing concentration until reach to  $5.0 \times 10^{-2}$  M of I<sup>-</sup> ions an inhibition of aluminium corrosion in 0.5 M HCl equal 13.35% and 10.05% from polarization and impedance respectively is found. Table 3 illustrates that  $E_{\text{corr}}$  values were shifted to more negative values with respect to that for the plank solution. This behaviour may be explained to that the I<sup>-</sup> ions polarized the Al sample. In general, EIS data emphasize the results obtained from polarization measurements. It observed that, increasing amount of I<sup>-</sup> ions  $> 2.5 \times 10^{-2}$  M lead to an increase in the charge transfer resistance  $R_{\text{ct}}$ , in addition to the occurrence of localized (pitting) corrosion on aluminium surface which appears as an inductive loop at low frequency in absence and presence of different concentrations of I<sup>-</sup> ions.

These results can be discussed according to: the I<sup>-</sup> ions have a dual action in relation to the stability of the oxide film on some metals. It was known to stimulate and inhibit the corrosion process.<sup>11,20,21</sup> The dependence of these functions on I<sup>-</sup> ions concentration differs, so it was found that the aggressive (acceleration) action predominates at low concentrations and the inhibitive action appears at high concentrations. I<sup>-</sup> ions in NaI and Cl<sup>-</sup> ions in HCl are classified as soft anions which have high corrosively, high adsorbability and high molar polarization. Accordingly, acid solutions containing such

Table 3. Electrochemical parameters and inhibition efficiency for corrosion of aluminum in 0.5 M HCl in absence and presence of different concentrations of NaI at 30 °C

Conc. M	Polarization						Impedance			
	$-E_{\text{corr}}$ (mV)	$b_a$ (V dec <sup>-1</sup> )	$-b_c$ (V dec <sup>-1</sup> )	$I_{\text{corr}}$ (mA cm <sup>-2</sup> )	$R_{\text{corr}}$ (mm day <sup>-1</sup> )	Inh.%	$R_{\text{sol}}$ (Ω cm <sup>2</sup> )	$R_{\text{ct}}$ (Ω cm <sup>2</sup> )	$C_{\text{dl}}$ (μF)	Inh.%
0.0	726.57	44.55	131.22	7.282	79.30	--	0.584	42.52	102.5	--
$1.0 \times 10^{-4}$	755.38	230.30	143.59	19.74	214.93	<b>-171.08</b>	2.226	14.08	87.14	<b>-195.93</b>
$2.5 \times 10^{-3}$	767.96	143.07	126.62	15.42	167.89	<b>-111.76</b>	2.453	18.40	177.5	<b>-126.45</b>
$1.0 \times 10^{-2}$	743.40	40.29	76.18	13.56	147.71	<b>-86.27</b>	2.051	24.06	45.72	<b>-75.00</b>
$2.5 \times 10^{-2}$	754.64	46.28	48.41	8.97	97.71	<b>-23.18</b>	2.158	37.45	101.8	<b>-11.26</b>
$3.0 \times 10^{-2}$	764.26	30.46	21.04	7.98	86.94	<b>-9.59</b>	1.992	40.21	74.37	<b>-3.62</b>
$5.0 \times 10^{-2}$	733.21	26.20	20.84	6.31	68.70	<b>13.35</b>	1.065	46.32	105.5	<b>10.05</b>

ions (i.e.  $\text{Cl}^-$  and  $\text{I}^-$ ) must be had aggressive character and hence stimulate aluminium corrosion especially at low concentrations of the aggressive ions (acceleration effect). This acceleration behaviour may be attributed to that both  $\text{I}^-$ ,  $\text{Cl}^-$  and the dissolving aluminium cation concentrated within the anode pit, forming a corrosive acolyte which accelerates corrosion.<sup>22</sup> In other words,  $\text{I}^-$  ions may participate in the corrosion mechanism as:

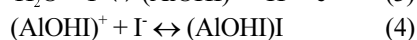

At low  $\text{I}^-$  ions concentration the complex formed on Al surface is soluble and hence increases the rate of corrosion, and decreases in the inhibitive action (or decreasing stimulating effect) the increasing  $\text{I}^-$  ions may be attributed to solubility of the formed complex with increasing  $\text{I}^-$  ions concentration, giving rise to a restraining effect, i.e. decreasing acceleration effect or in some cases inhibiting corrosion rate. Moreover,  $\text{I}^-$  ions adsorbed on the metal surface by chemisorption process<sup>22,23</sup> and the increase  $\text{I}^-$  ions concentration increase the polarizability which enhance the adsorption not due to electrostatic effects alone, but also some covalent bonding to the metal must which be involved.

Fig. 7 indicates that the adsorption of  $\text{I}^-$  ions on

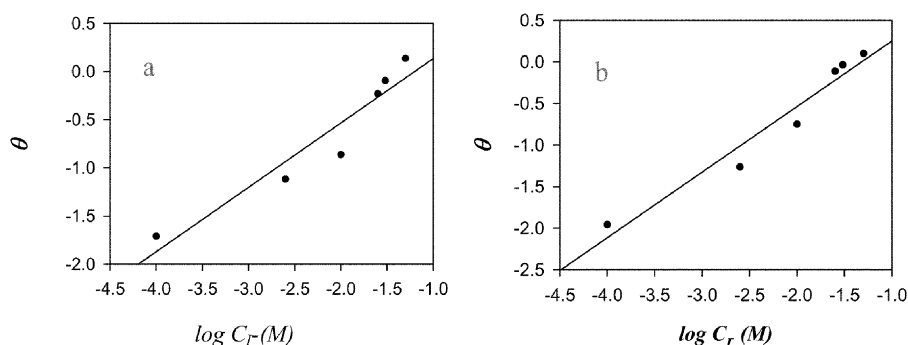

Fig. 7. Temkin adsorption isotherm plots for aluminum sample in 0.5 M HCl containing different concentration of iodide ions a) polarization, b) impedance.

Table 4. Linear regression and adsorption parameters for iodide ions on Al surface from 0.5 M HCl solution at 30° C.

Techniques	Correlation coefficient C.C	$f$	$a$	$K_{\text{ads}} (\text{M}^{-1})$	$\Delta G_{\text{ads}}^{\circ} (\text{kJmol}^{-1})$
Polarization	91	1.493	-0.747	3.320	-13.135
Impedance	95	1.266	-0.633	3.732	-13.437

aluminium surface from 0.5 M HCl solutions obeys Temkin adsorption isotherm which is given by the following equation:

$$\theta = (1/f) \ln K + (1/f) \ln C_1^- \quad (5)$$

Where  $f$  is the Temkin heterogeneity factor which is related to the so- called Frumkin interaction parameter ( $a$ ) by the relation:<sup>24</sup>

$$f = -2a \quad (6)$$

the linear regression between  $\theta$  and  $\log C_1^-$  and the adsorption parameters were recorded in Table 4.

Negative values for Frumkin interaction parameter were observed ( $a < 0.00$ ), which should mean that the repulsive forces between the adsorbed  $\text{I}^-$  ions and dominant.<sup>24</sup> The significant characteristic for  $a < 0.00$  is that one can not be obtained at high coverages, important for good inhibiting efficiency, except for the extremely high concentrations. Economically this is inconvenient. According to the previous result lower values for  $\Delta G_{\text{ads}}^{\circ}$  were expected Table 4.

#### Synergistic inhibition effect of $\text{I}^-$ ions and AZI extract on Aluminium corrosion in 0.5 M HCl solution at 30 °C.

Electrochemical (polarization and impedance)



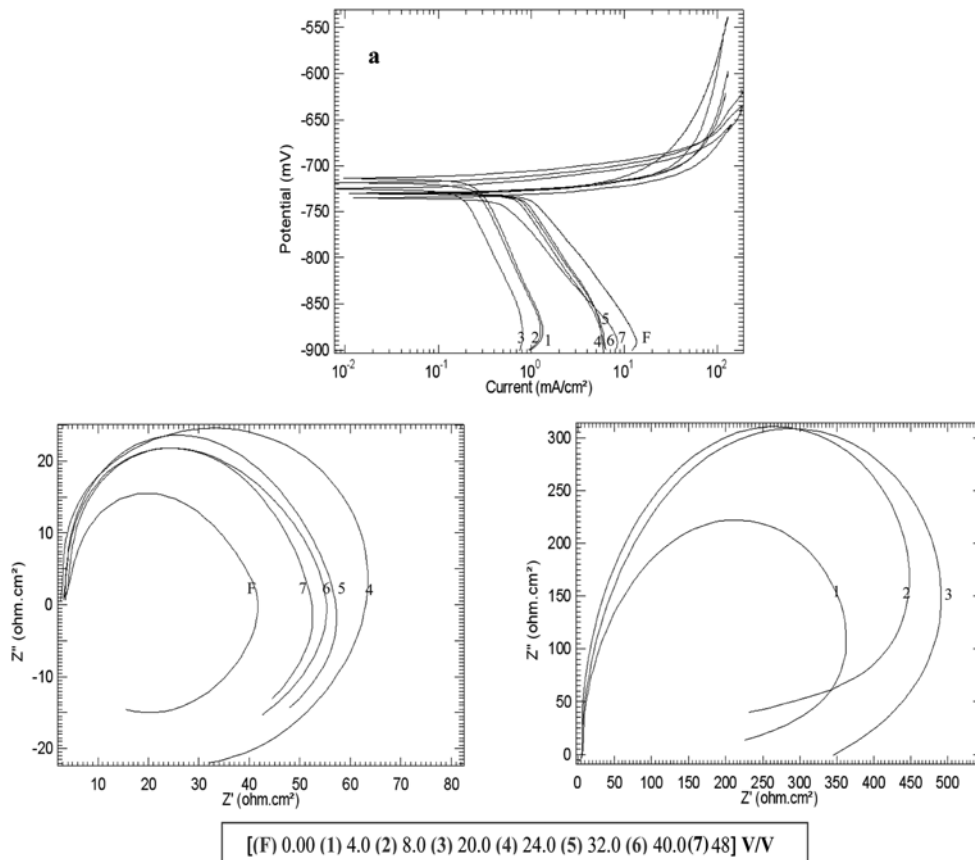

Fig. 8. Electrochemical of Al sample corrosion in 0.5 M HCl +  $1 \times 10^{-2}$  M I for various concentrations of AZI extract at 30 °C from (a) polarization, (b) impedance.

study of aluminium sample were performed in 0.5 M HCl in absence and presence of:

**Fixed concentration of iodide ion and different concentrations of *Azadirachta Indica* extract:**

Fig. 8 shows the influence 0.01 M of I addition on potentiodynamic polarization curves and Nyquist plots of Al sample in 0.5 M HCl solution in absence and presence of different concentrations of AZI extract. The various electrochemical parameters and Inh.% calculated from Tafel and Nyquist plots are shown in Table 5. It can be observed from the table that, the Inh.% has very high values in presence of 0.01 M of NaI at low concentrations of AZI extract up to 20% v/v, then, they were decreased with increase the concentration of AZI extract.  $E_{\text{corr}}$  values were shifted to less negative (more positive) with the addition of I ions, and  $R_{\text{ct}}$  was found to

increase with respect to that in absence of I ions while  $C_{\text{dl}}$  values tend to decrease, Table 5. This can be explained due to the synergistic inhibitive effect due to the combination of AZI extract and I ions for the corrosion of aluminium in 0.5 M HCl solution at only low concentrations of AZI extract which attributed to the formation of ionic complex (ExI) between AZI extract component and I ions.

The synergistic effect obtained by the addition of I ions is greater at lower concentrations and considerably less at higher concentrations of AZI extract. This is due to the fact that I ions acts more effectively at lower concentrations of AZI extract enhancing the efficiency more than in the case of higher concentrations. Variation of surface coverage ( $\theta$ ) in the presence of I ions and different concentrations of AZI extract follows the same trend.<sup>25</sup>

Table 5. Electrochemical parameters and inhibition efficiency for corrosion of aluminum in 0.5 M HCl in absence and presence of different concentrations of **AZI** extract +  $1.0 \times 10^{-2}$  M NaI at 30 °C.

Conc. of AZI V/V	Polarization						Impedance			
	$-E_{\text{corr.}}$ (mV)	$b_a$ (V dec <sup>-1</sup> )	$-b_c$ (V dec <sup>-1</sup> )	$I_{\text{corr.}}$ (mA cm <sup>-2</sup> )	$R_{\text{corr.}}$ (mm day <sup>-1</sup> )	Inh.%	$R_{\text{sol.}}$ ( $\Omega$ cm <sup>2</sup> )	$R_{\text{ct.}}$ ( $\Omega$ cm <sup>2</sup> )	$C_{\text{dl.}}$ ( $\mu$ F)	Inh.%
0.0	743.40	40.29	76.18	13.56	147.7	-86.27	2.051	24.06	45.72	-75.00
4	712.58	12.11	12.79	3.36	36.61	53.86	14.95	356.8	11.34	88.32
8	718.46	12.11	11.98	2.90	31.59	60.18	29.62	405.8	8.480	89.73
20	722.87	11.77	11.08	2.71	29.50	62.78	26.94	461.9	15.12	90.98
24	734.64	25.86	16.56	5.16	56.16	29.18	25.75	69.60	121.2	41.67
32	729.50	27.11	65.56	6.13	66.72	15.82	3.661	53.16	86.91	20.83
40	729.50	30.12	76.37	6.41	69.85	11.97	3.14	52.22	110.2	20.42
48	729.50	47.81	76.52	6.71	73.12	7.80	3.06	49.29	85.18	16.67

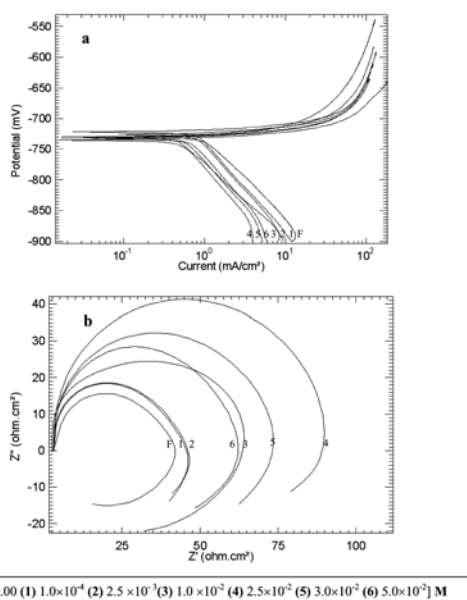

Fig. 9. (a) polarization and (b) impedance curves for Al sample corrosion in 0.5 M HCl + different concentrations of I<sup>-</sup> and presence of 24% v/v of AZI extract at 30 °C.

#### Fixed concentration of **AZI** extract and different concentrations of iodide ion:

The effect of the addition of different concentrations ( $1.0 \times 10^{-4}$  -  $5.0 \times 10^{-2}$ ) M of I<sup>-</sup> ions on the corrosion inhibition of aluminium in 0.5 M HCl in presence of 24% v/v of **AZI** extract was studied using polarization and impedance measurements. Fig. 9 represents polarization curves and Nyquist plots. The electrochemical parameters are recorded in Table 6.

It is obvious from Fig. 9(a) that the cathodic polarization curves shifted to less current densities, while the anodic polarization curves not affect in presence of concentrations  $> 1.0 \times 10^{-4}$  M of I<sup>-</sup> ions. Also, Table 6 represents that  $E_{\text{corr.}}$  values shifted to less negative values comparing with that in presence of 24% v/v of **AZI** extract alone, and the inhibition efficiency increase with increasing I<sup>-</sup> ions concentrations until  $2.5 \times 10^{-2}$  M but, it is more less than that obtained in presence of **AZI** extract alone.

Table (6) Electrochemical parameters and inhibition efficiency for corrosion of aluminum in 0.5 M HCl in absence and presence of different concentrations of NaI + 24% **AZI** extract at 30 °C.

Conc. V/V	Polarization						Impedance			
	$-E_{\text{corr.}}$ (mV)	$b_a$ (V dec <sup>-1</sup> )	$-b_c$ (V dec <sup>-1</sup> )	$I_{\text{corr.}}$ (mA cm <sup>-2</sup> )	$R_{\text{corr.}}$ (mm day <sup>-1</sup> )	Inh.%	$R_{\text{sol.}}$ ( $\Omega$ cm <sup>2</sup> )	$R_{\text{ct.}}$ ( $\Omega$ cm <sup>2</sup> )	$C_{\text{dl.}}$ ( $\mu$ F)	Inh.%
0.0	732.82	56.04	105.58	4.00	43.63	45.07	2.898	139.40	553.1	70.13
$1.0 \times 10^{-4}$	720.59	27.85	149.67	7.09	77.21	2.67	1.737	43.98	104.1	5.26
$2.5 \times 10^{-3}$	725.03	30.48	96.36	6.84	74.53	6.07	2.009	44.09	100.2	5.50
$1.0 \times 10^{-2}$	734.64	25.86	16.65	5.16	56.16	29.18	25.75	69.60	121.2	41.67
$2.5 \times 10^{-2}$	730.95	25.20	67.95	4.77	52.00	34.50	2.969	87.90	67.00	52.60
$3.0 \times 10^{-2}$	732.43	26.14	49.50	5.31	57.88	27.08	2.515	72.17	84.56	42.27
$5.0 \times 10^{-2}$	733.91	28.61	53.50	5.50	59.94	24.47	2.128	60.75	75.87	31.41

The results obtained from impedance method enhance the results obtained from polarization. Fig. 9(b) shows an increase in  $R_{ct}$  values when added different concentrations of  $I^-$  ions until reach to  $2.5 \times 10^{-2}$  M then  $R_{ct}$  decrease by increasing  $I^-$  ions concentration.

It can be seen that the maximum synergistic effect is observed at  $2.5 \times 10^{-2}$  M NaI.

#### Synergistic parameter and synergistic mechanism:

Aramaki and Hackerman<sup>26</sup> calculated the synergistic parameter  $S_\theta$  from the following equation:

$$S_\theta = (1 - \theta_{(1+2)}) / (1 - \theta'_1 - \theta'_2) \quad (7)$$

Where:  $\theta_{(1+2)} = (\theta_1 + \theta_2) - (\theta'_1 \theta'_2)$

$\theta_1$  = surface coverage by anion

$\theta_2$  = surface coverage by cation

$\theta'_{(1+2)}$  = measured surface coverage by both anion and cation

All the  $\theta_1$ ,  $\theta_2$ ,  $\theta_{(1+2)}$ ,  $\theta'_{(1+2)}$  and  $S_\theta$  values obtained from polarization and impedance measurements for aluminium in 0.5 M HCl solution whether in the case of added certain concentration of  $I^-$  and different concentrations of *AZI* extract or added different concentrations of  $I^-$  and fixed concentration of *AZI* extract.

Tables (5 and 6) and the following conclusions can be obtained:

- As observed from Tables (7 and 8), all the measured values of  $\theta'_{(1+2)}$  are higher than either  $\theta_1$  or  $\theta_2$

Table 7. Surface coverage and synergism parameter values for aluminum sample in 0.5 M HCl in presence of different concentrations of *AZI* extract+ 0.01 I<sup>-</sup> M at 30 °C from polarization and impedance studies

Method	$C_{inh.}$ (v/v)	$C_{I^-}$ (M)	$\theta_1$	$\theta_2$	$\theta_1 + \theta_2$ (calculated)	$\theta_1 + \theta_2'$ (measured)	$S_\theta$
Polarization	---	$1.0 \times 10^{-2}$	-0.863	---	---	---	---
	4	---	---	0.077	---	---	---
	4	$1.0 \times 10^{-2}$	---	---	-0.720	0.539	<b>3.73</b>
	8	---	---	0.106	---	---	---
	8	$1.0 \times 10^{-2}$	---	---	-0.666	0.602	<b>4.18</b>
	20	---	---	0.164	---	---	---
	20	$1.0 \times 10^{-2}$	---	---	-0.557	0.628	<b>4.19</b>
	24	---	---	0.451	---	---	---
	24	$1.0 \times 10^{-2}$	---	---	-0.023	0.292	<b>1.45</b>
	32	---	---	0.329	---	---	---
	32	$1.0 \times 10^{-2}$	---	---	-0.250	0.158	<b>1.49</b>
	40	---	---	0.256	---	---	---
	40	$1.0 \times 10^{-2}$	---	---	-0.386	0.120	<b>1.57</b>
	48	---	---	0.136	---	---	---
48	$1.0 \times 10^{-2}$	---	---	-0.610	0.078	<b>1.75</b>	
Impedance	---	$1.0 \times 10^{-2}$	-0.708	---	---	---	---
	4	---	---	0.042	---	---	---
	4	$1.0 \times 10^{-2}$	---	---	-0.677	0.883	<b>14.33</b>
	8	---	---	0.167	---	---	---
	8	$1.0 \times 10^{-2}$	---	---	-0.458	0.897	<b>14.16</b>
	20	---	---	0.542	---	---	---
	20	$1.0 \times 10^{-2}$	---	---	0.199	0.909	<b>8.80</b>
	24	---	---	0.701	---	---	---
	24	$1.0 \times 10^{-2}$	---	---	0.477	0.417	<b>0.90</b>
	32	---	---	0.652	---	---	---
	32	$1.0 \times 10^{-2}$	---	---	0.391	0.208	<b>0.77</b>
	40	---	---	0.270	---	---	---
	40	$1.0 \times 10^{-2}$	---	---	0.270	0.204	<b>0.92</b>
	48	---	---	0.375	---	---	---
48	$1.0 \times 10^{-2}$	---	---	-0.094	0.167	<b>1.313</b>	

and calculated values  $\theta_{(1+2)}$ , and the  $S_0$  values are more than unity, suggesting that the inhibitive effect of the anion and cation is synergistic in nature.<sup>9,27,28</sup>

- Synergistic behaviour between anions and cations may be attributed to cooperative or competitive adsorption.<sup>29</sup>

If the measured  $\theta'_{(1+2)}$  is higher than the calculated  $\theta_{(1+2)}$  and  $S_0 > 1$ , the synergistic is attributed to cooperative adsorption on the surface by an electrostatic interaction between both ions. The synergistic inhibition of the ions is ascribed to competitive adsorption as the measured  $\theta'_{(1+2)}$  is lower than the calculated one  $\theta_{(1+2)}$  and  $S_0 < 1$ . By comparing the recorded values of  $\theta_{(1+2)}$ ,  $\theta'_{(1+2)}$  and  $S_0$  (Table 7), most of the values of  $S_0$  are greater than unity and  $\theta'_{(1+2)}$  is higher than  $\theta_{(1+2)}$ , in presence of different concentrations of *AZI* extract, this attributed to cooperative adsorption or co-adsorption,<sup>30-32</sup> clearly showing

that the corrosion inhibition brought out by *AZI* extract and iodide in combination is synergistic in nature. Thus it can be concluded that the ionic complex form between  $\Gamma$  ions and *AZI* extract components, then the  $\Gamma$  ions inter to the metallic part of the double layer, the charge of the ion form the charge on the metal surface, which is in turn attracts positively charged inhibitor cations rendering the adsorption more effective.<sup>33</sup> At higher concentrations of *AZI* extract there are an accumulation of molecules in solution lead to desorption of adsorbed ions from the surface this cause to accelerate the reaction by  $\Gamma$  ions and decrease the inhibition. The synergistic effect obtained by the addition of iodide is greater at lower concentrations and considerably less at higher concentrations of *AZI* extract (see Table 7). It is due to the fact that iodide ions acts more effectively at lower concentrations of *AZI*

Table 8. Surface coverage and synergism parameter values for aluminum sample in 0.5 M HCl in presence of different concentrations of  $\Gamma$  ions + 24% v/v of *AZI* extract at 30 °C from polarization and impedance studies

Method	$C_1^-$ (M)	$C_{inh.}^+$ (v/v)	$\theta_1$	$\theta_2$	$\theta_1+\theta_2$ (calculated)	$\theta_1+\theta_2'$ (measured)	$S_0$
Polarization	---	24	---	0.451	---	---	---
	$1.0 \times 10^{-4}$	---	-1.711	---	---	---	---
	$1.0 \times 10^{-4}$	24	---	---	-0.488	0.027	<b>1.53</b>
	$2.5 \times 10^{-3}$	---	-1.118	---	---	---	---
	$2.5 \times 10^{-3}$	24	---	---	-0.163	0.061	<b>1.24</b>
	$1.0 \times 10^{-2}$	---	-0.863	---	---	---	---
	$1.0 \times 10^{-2}$	24	---	---	-0.022	0.292	<b>1.44</b>
	$2.5 \times 10^{-2}$	---	-0.232	---	---	---	---
	$2.5 \times 10^{-2}$	24	---	---	0.324	0.345	<b>1.03</b>
	$3.0 \times 10^{-2}$	---	-0.096	---	---	---	---
	$3.0 \times 10^{-2}$	24	---	---	0.395	0.271	<b>0.83</b>
	$5.0 \times 10^{-2}$	---	0.134	---	---	---	---
$5.0 \times 10^{-2}$	24	---	---	0.525	0.245	<b>0.63</b>	
Impedance	---	24	---	0.701	---	---	---
	$1.0 \times 10^{-4}$	---	-1.960	---	---	---	---
	$1.0 \times 10^{-4}$	24	---	---	0.115	0.053	<b>0.91</b>
	$2.5 \times 10^{-3}$	---	-1.265	---	---	---	---
	$2.5 \times 10^{-3}$	24	---	---	0.323	0.055	<b>0.72</b>
	$1.0 \times 10^{-2}$	---	-0.750	---	---	---	---
	$1.0 \times 10^{-2}$	24	---	---	0.477	0.417	<b>0.90</b>
	$2.5 \times 10^{-2}$	---	-0.113	---	---	---	---
	$2.5 \times 10^{-2}$	24	---	---	0.667	0.526	<b>0.70</b>
	$3.0 \times 10^{-2}$	---	-0.036	---	---	---	---
	$3.0 \times 10^{-2}$	24	---	---	0.690	0.423	<b>0.54</b>
	$5.0 \times 10^{-2}$	---	0.101	---	---	---	---
$5.0 \times 10^{-2}$	24	---	---	0.731	0.314	<b>0.39</b>	

extract enhancing the efficiency more than in the case of higher concentrations.

It was observed from Table (8) that values of  $S_0$  greater than unity at low concentrations of  $\Gamma$  ions and  $S_0 < 1$  at high concentrations, and the values of  $\theta'_{(1+2)}$  (measured) less than  $\theta_{(1+2)}$  (calculated) this indicates that the competitive adsorption well occur between  $\Gamma$  ions and *AZI* extract molecules especially at low concentrations of  $\Gamma$  ions, and it is clear from Table (8) that the addition of different concentrations of  $\Gamma$  ions the synergistic effect increase with increasing  $\Gamma$  ions concentrations up to  $2.5 \times 10^{-2}$  M then it decreases with further increase in  $\Gamma$  ions concentration. This due to the dual action of  $\Gamma$  ions<sup>34</sup> in relation to the stability of the oxide film on aluminium surface; it was inhibit or accelerate the corrosion dependent<sup>8,14,15</sup> to  $\Gamma$  ions concentration. This is in agreement to the obtained result in presence of 24% v/v of *AZI* extract, which give less inhibition efficiency at low concentration of  $\Gamma$  ions and increase by increasing  $\Gamma$  ions concentration until reach to  $2.5 \times 10^{-2}$  M (micelle concentration) after this the Inh.% decrease with increase  $\Gamma$  ions concentration. At low concentrations of  $\Gamma$  ions and according to aggressive characteristics of  $\Gamma$  ions and it concentrated within the anode pits on the surface forming a soluble complex which accelerates corrosion and give Inh.% less than that in presence of *AZI* extract in absence of  $\Gamma$  ions, the Inh.% increase with increasing the concentration of  $\Gamma$  ions due to decrease of the complex solubility and the adsorption of  $\Gamma$  ions. At  $C > 2.5 \times 10^{-2}$  M of  $\Gamma$  ions, the competitive will occur between  $\Gamma$  ions and *AZI* extract components to adsorption on aluminium surface lead to a decrease in inhibitor efficiency.

## CONCLUSIONS

*Azadirachta Indica* plant extract acts as an inhibitor especially at low concentrations (4-24%) v/v, the Inh.% increased with increasing concentration of *AZI* extract, but after 24% v/v the corrosion rate was increased with the increase the extract concentration. This is probably caused by the formation of insoluble complex at lower concentrations, but at

higher concentrations of *AZI* extract, the complex formed is suggested to become soluble which leads to less inhibition.

The addition of  $\Gamma$  ions to aluminium in 0.5 M HCl solution leads to stimulate or to inhibit the corrosion rate depending on the  $\Gamma$  ions concentration.

The addition of 0.01 M NaI in presence of different concentrations (4-24%)v/v of *AZI* extract showed that the Inh.% has very high values due to the formation of ionic compound  $\text{Ex}\Gamma$  between  $\Gamma$  ions and *AZI* extract composition. But at higher concentrations of *AZI* extract, competitive adsorption between  $\Gamma$  ions and the formed compound leading to less Inh.%.

The addition of different concentrations ( $1.0 \times 10^{-4}$ -  $5.0 \times 10^{-2}$ ) M of  $\Gamma$  ions in presence of 24% v/v of *AZI* extract showed that the inhibition efficiency decreased in presence of  $\Gamma$  ions with *AZI* extract than in presence of *AZI* extract alone. But when  $\Gamma$  reach to  $2.5 \times 10^{-2}$  M of  $\Gamma$  ions the Inh.% decreased with increasing  $\Gamma$  ions concentration. This attributed to that the excess of  $\Gamma$  ions will be free causing corrosion of Al so decrease of inhibition will occurred.

Values of the synergism parameter  $S_0$  are greater than unity, showing that the corrosion inhibition brought out by *AZI* extract and  $\Gamma$  ions in combination is synergistic in nature.

## REFERENCES

1. H. H. Uhlig, "Corrosion and Corrosion Control", John Wiley and Sons Inc., 2nd edn. (1971).
2. U. J. Ekpe, E. E. Ebenso and U. J. Ibok, *J. W. Afr. Sci. Assoc.*, **1994**, 37, 13.
3. O. K. Abiola, N. C. Oforika and E. E. Ebenso, *J. Corros. Sci. & Eng.*, **2004**, 5(10), 1.
4. R. Al-Elyani and S. Khalifa, *J. Egypt. Ger. Soc. Zool.*, **1996**, 19, 37.
5. S. P. Basak and D. P. Chakraborty, *J. Indian Chem. Soc.*, **1968**, 45(5), 466.
6. G. H. Cartledge, *J. Phys. Chem.*, **1952**, 60, 32.
7. M. J. Pryor, *Z. Electrochem.*, **1958**, 62, 728.
8. W. I. Lorenz, *Corros. Sci.*, **1965**, 5, 121.
9. A. J. Arvia and J. J. Podesta, *Corros. Sci.*, **1968**, 8, 203.
10. H. B. Rudresh and S. M. Mayanna, *Corros. Sci.*, **1979**, 19, 361.

11. G. K. Gomma, *Mater. Chem. Phys.*, **1998**, *55*, 241.
  12. E. Kalman, I. Lukovits and G. Palinkas, *ACH- Models Chem.*, **1995**, *1324*, 527.
  13. S. T. Arab and A. M. Al-Turkustani, *International J. Chem.*, **2002**, *12(4)*, 249.
  14. A. Frignani, G. TrabANELLI, F. Zucchi and M. Zucchini, Proceedings of the 4<sup>th</sup> Eur. Sym. on Corros. Inh. Univ. Ferrara, Italy, **1975**, *3*, 652.
  15. F. M. Donahue and K. Nobe, *J. Electrochem. Soc.*, **1967**, *114*, 1012.
  16. J. R. Macdonald, *Impedance Spectroscopy*, Wiley, New York, 1987.
  17. C. M. A. Brett, *Corros. Sci.*, **1992**, *33*, 203.
  18. B. Berge, K. Grijotheim, G. Kronhn, R. Neumann and K. Torkiep, *Light Metals*, (edited by SRLeavitl) Proceeding of 105<sup>th</sup> annual meeting, **1976**, 23.
  19. M. Kliskic, J. Radosevis, S. Gudic and V. Kalatinik, *J. Appl. Electrochem.*, **2002**, *30*, 823.
  20. H. J. Scheibe and H. G. Feller, *Corros. Sci.*, **1973**, *13*, 11.
  21. G. Bianchi, F. Mazza and S. Torchio, *Corros. Sci.*, **1973**, *13*, 165.
  22. T. Suzuki, *Corrosion-NACE*, **1973**, *29*, 18.
  23. K. K. Srtvastava and B. Sanyal, *Chem. Eng. World*, **1977**, *12(6)*, 65.
  24. O. L. Riggs, *Corrosion- NACE*, **1968**, *24*, 125.
  25. S. Syed Azim, S. Muralidharan and S. V. Iyer, *J. Appl. Electrochem.*, **1995**, *25*, 495.
  26. K. Aramaki and N. Hackerman, *J. Electrochem. Soc.*, **1969**, *116*, 568.
  27. K. Aramaki, M. Hagiwara and H. Nishihawa, *Corros. Sci.*, **1987**, *27*, 487.
  28. M. A. Quraishi and J. Rawat, *Mater. Chem. & Phys.*, **2002**, *73*, 118.
  29. T. Kawai, H. Nishihara and K. Aramaki, *Corros. Sci.*, **1996**, *38(2)*, 225.
  30. M. Hosseini, S. F. L. Mertens and M. R. Arshadi, *Corros. Sci.*, **2003**, *54*, 1473.
  31. S. T. Arab and K. M. Emran, *J. Saudi Chem. Soc.*, **2006**, *10(1)*, 199.
  32. S. T. Arab and K. M. Emran, *Commun. Fac. Sci. Univ. Ank. Series B*, **2006**, *52(1)*, 1.
  33. L. Jha, R. R. Singh and G. Singh, *J. Electrochem. Soc. India*, **1990**, *6(39)*, 71.
  34. D. M. Brasher, *Br. Corros. J.*, **1969**, *4*, 122.
-